

GRANGE

1866

OWN ONE OF THE CITY'S MOST
COVETED ADDRESS



AT THE GLOBAL DESTINATION
THAT LIGHTS UP THE WORLD



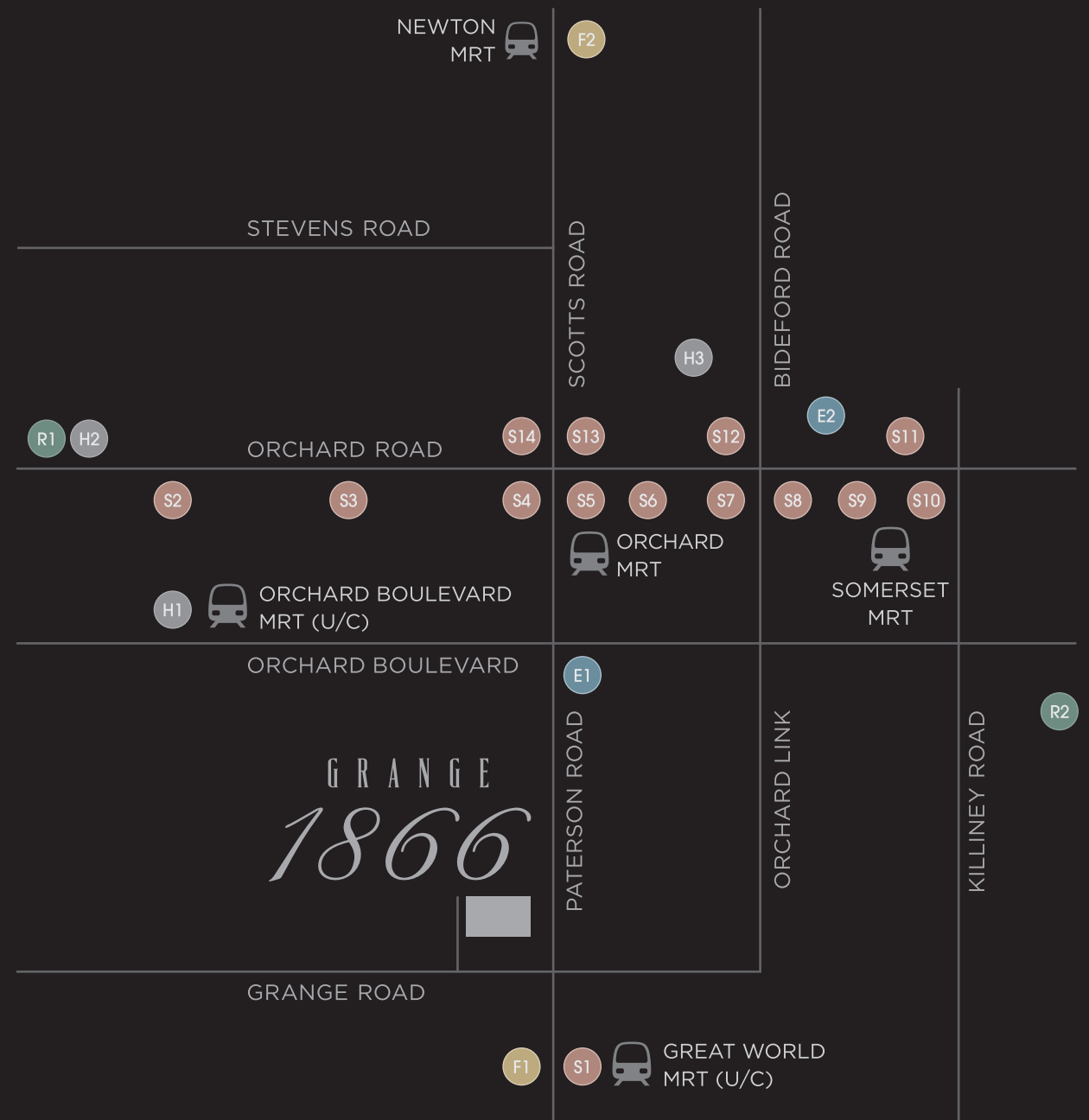

FOOD & BEVERAGE

- F1 Zion Riverside Food Centre
- F2 Newton Food Centre

EDUCATION

- E1 ISS International School
- E2 Chatsworth International School

MEDICAL

- H1 Camden Medical Centre
- H2 Gleneagles Hospital / Medical Centre
- H3 Mount Elizabeth Hospital

RECREATIONAL

- R1 Singapore Botanic Gardens
- R2 Fort Canning Park

RETAIL

- S1 Great World City
- S2 Tanglin Mall
- S3 Forum The Shopping Mall
- S4 Wheelock Place
- S5 ION Orchard
- S6 Wisma Atria
- S7 Ngee Ann City
- S8 Mandarin Gallery
- S9 313 @ Somerset
- S10 Orchard Central
- S11 The Centrepoin
- S12 The Paragon
- S13 Tang Plaza
- S14 Shaw House

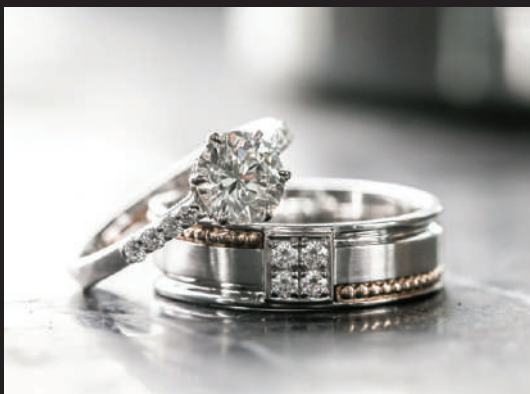

Grange 1866 offers a metropolitan lifestyle at your doorstep. In a precinct of exceptional charm and luxury, everyday is like a dream come true. With the latest fashion couture to the most talk-about masterpiece on the wrist, this distinct neighbourhood matches your status. Grange 1866, your perfect runway.

60 LUXURIOUS HOMES
IN IMMACULATE BEAUTY AND
UNPRETENTIOUS OPULENCE



Welcome home to the private side of a world-class city.
Be impressed by the limited collection of sophisticated turnkey
residences with fine finishes and sought-after surroundings.
Grange 1866, a new milestone in extraordinary affluence.





Arrived at a world of prestige and luxury. Here's where you truly belong. Grace and elegance take centre stage the moment you come home. Grange 1866, timeless moments and exclusivity await at this freehold development.



Artist's Impression



THE INFINITE INDULGENCES



Artist's Impression



Freedom is a luxury - own your personal, private spaces to spend some quiet moments in renewing your body and soul. Bask in the sun, swim in the water, work out in the gym or celebrate an occasion, all in the private spaces we created for your indulgences. Grange 1866 - freedom is a given.



EACH PRIVATE
SANCTUARY
COMES WITH HIGHEST
LEVEL OF QUALITY
AND PERFECT VIEWS



An extraordinary history has resulted in a new landmark that serves as a gateway to a prestigious lifestyle. Using quality materials and versatile plannings to create exclusive homes, you can count on your blessings every day. Grange 1866 - where endless happiness begins.





The thoughtful spatial design brings out efficient spaces for more room to explore. With renowned brands for finishes and fittings, life is luxurious and pampering. Grange 1866, live to the fullest and finest.



SITE PLAN

1ST FLOOR

- A Electrical Substation (ESS)
 - B Bin Centre
 - C Genset (Above ESS)
 - D Water Bulk Meter
 - E Valve Chamber
 - F M&E Shaft
 - G Domestic Water Tank (Lower Roof Floor)
 - H Bicycle Parking
- 1 Water Cascade
 - 2 Waterfall Lawn
 - 3 Garden Lawn
 - 4 Arrival Concierge
 - 5 Fern Garden
 - 6 BBQ Gourmet Terrace

2ND FLOOR

- 7 Lap Pool
- 8 Jacuzzi
- 9 Sun Deck
- 10 The Pavilion
- 11 Feature Green Wall
- 12 Sensory Garden
- 13 Outdoor Shower
- 14 Gym



DIAGRAMMATIC CHART

	01	02	LC	03	04
16	B1 (R)	B2 (R)		B4 (R)	A (R)
15	B1	B2		B3	A
14	B1	B2		B3	A
13	B1	B2		B4	A
12	B1	B2		B4	A
11	B1	B2		B3	A
10	B1	B2		B3	A
9	B1	B2		B4	A
8	B1	B2		B4	A
7	B1	B2		B3	A
6	B1	B2		B3	A
5	B1	B2		B4	A
4	B1	B2		B4	A
3	B1	B2		B3	A
2	B1	B2 (G)		B3 (G)	A
1					
B1	BASEMENT CARPARK				

- 1-Bedroom
- 2-Bedroom
- 2-Bedroom Premium
- 2-Bedroom Suite
- Drop Off / Lobby / Carpark

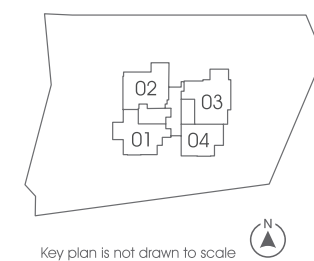

Key plan is not drawn to scale

1 - BEDROOM

TYPE A

49 SQM / 527 SQFT
#02 - 04 to #15 - 04

TYPE A (R)

65 SQM / 700 SQFT
#16 - 04
(Inclusive of 16 sqm high-volume void)

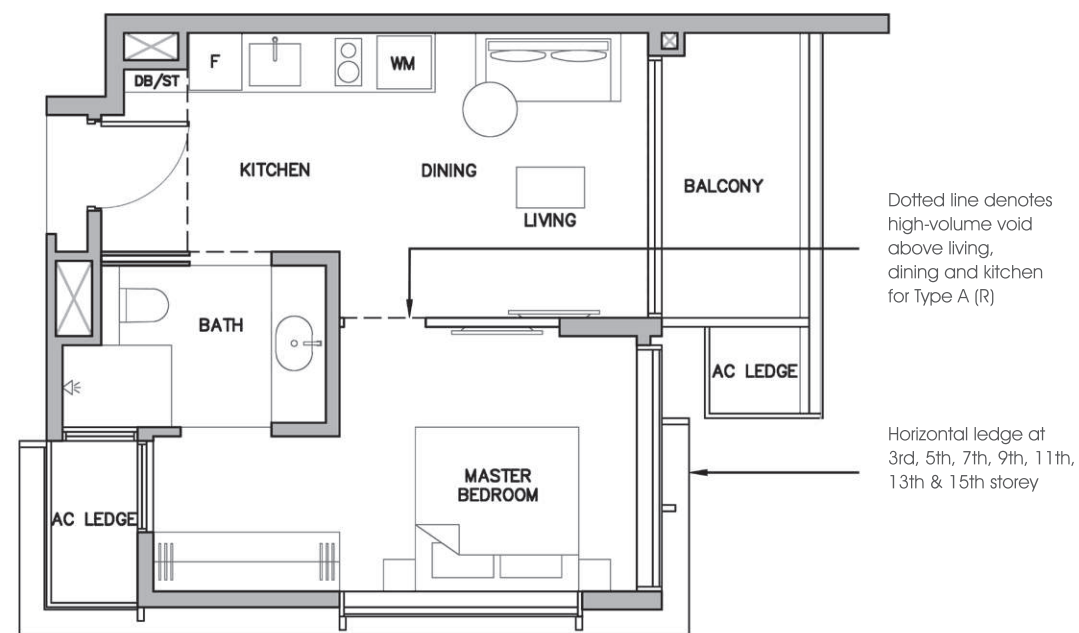

Dotted line denotes high-volume void above living, dining and kitchen for Type A (R)

Horizontal ledge at 3rd, 5th, 7th, 9th, 11th, 13th & 15th storey

2 - BEDROOM

TYPE B1

66 SQM / 710 SQFT
#02 - 01 to #15 - 01

TYPE B1 (R)

79 SQM / 850 SQFT
#16 - 01
(Inclusive of 13 sqm high-volume void)

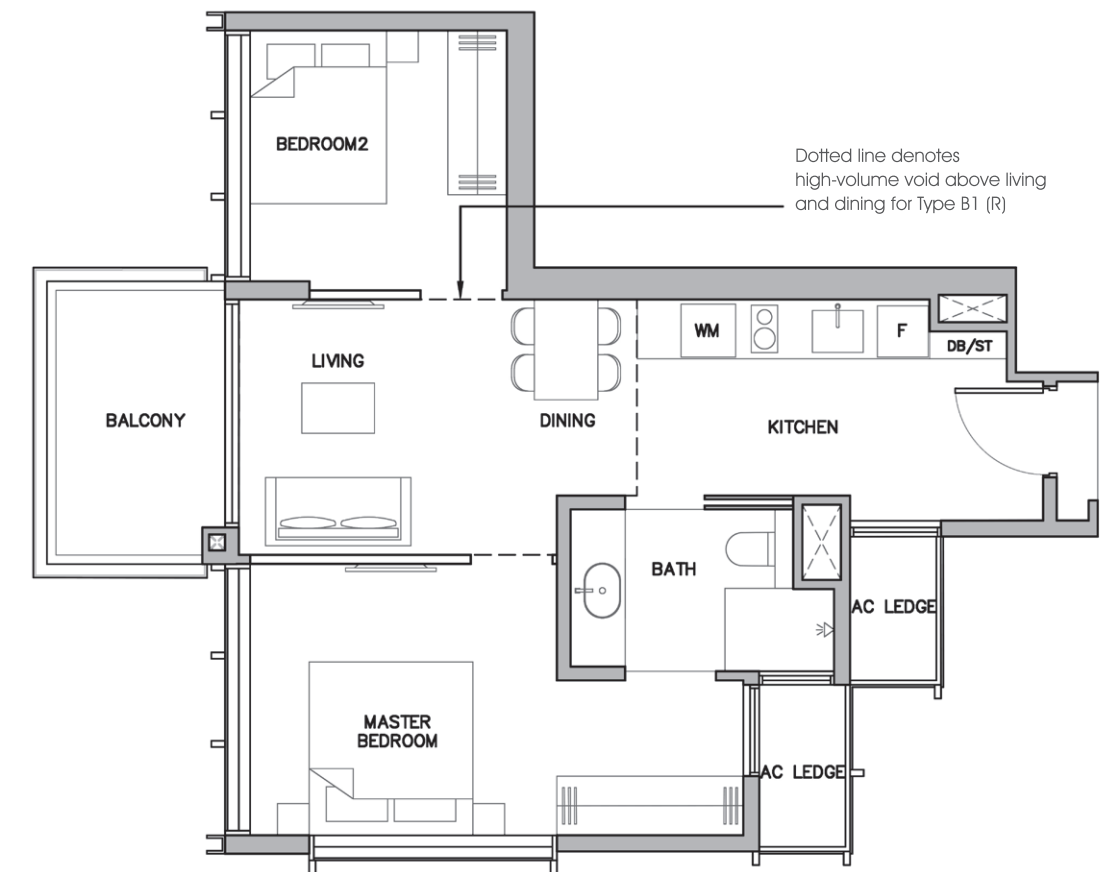

Dotted line denotes high-volume void above living and dining for Type B1 (R)

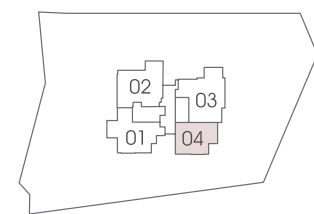

Key plan is not drawn to scale



LEGEND:
F - Fridge
WM - Washer cum Dryer
DB - Distribution Board
ST - Storage

Area includes air-con (a/c) ledge, private enclosed space (PES), balcony and strata void area where applicable. Please refer to the key plan of the unit plans shown in the brochure for orientation. The plans are subject to change as may be approved by relevant authorities. All floor plans are approximate measurements only and are subject to government re-survey. The balcony shall not be enclosed unless with the approved balcony screen. Please refer to the drawing titled approved typical balcony screen design.

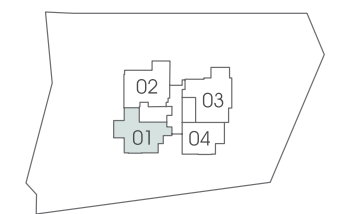

Key plan is not drawn to scale



LEGEND:
F - Fridge
WM - Washer cum Dryer
DB - Distribution Board
ST - Storage

Area includes air-con (a/c) ledge, private enclosed space (PES), balcony and strata void area where applicable. Please refer to the key plan of the unit plans shown in the brochure for orientation. The plans are subject to change as may be approved by relevant authorities. All floor plans are approximate measurements only and are subject to government re-survey. The balcony shall not be enclosed unless with the approved balcony screen. Please refer to the drawing titled approved typical balcony screen design.

2 - BEDROOM PREMIUM

TYPE B2

71 SQM / 764 SQFT
#03 - 02 to #15 - 02

TYPE B2 (G)

71 SQM / 764 SQFT
#02 - 02

TYPE B2 (R)

86 SQM / 926 SQFT
#16 - 02
(Inclusive of 15 sqm high-volume void)

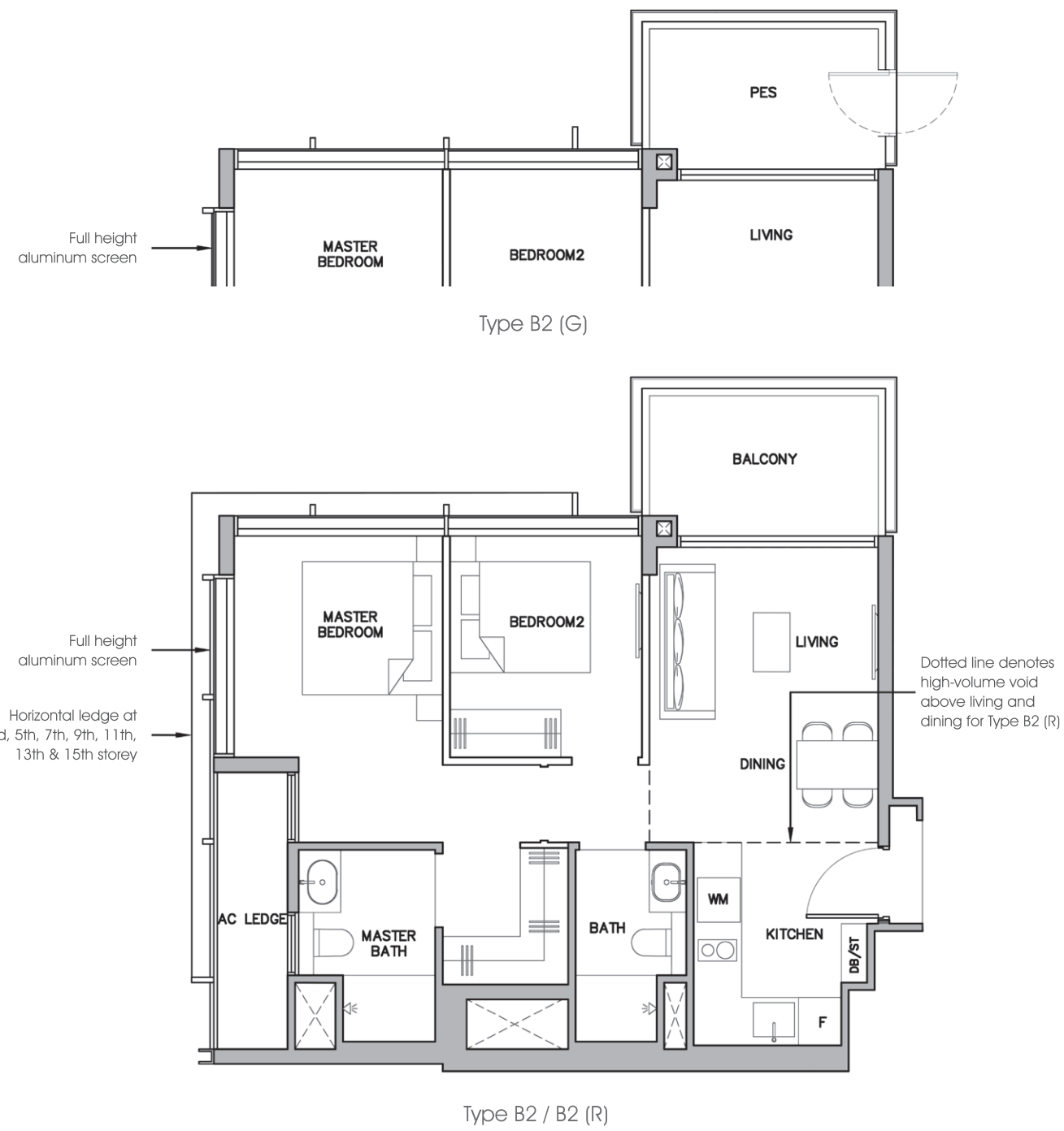

2 - BEDROOM SUITE

TYPE B3

76 SQM / 818 SQFT
#03 - 03
#06 - 03 to #07 - 03
#10 - 03 to #11 - 03
#14 - 03 to #15 - 03

TYPE B3 (G)

76 SQM / 818 SQFT
#02 - 03

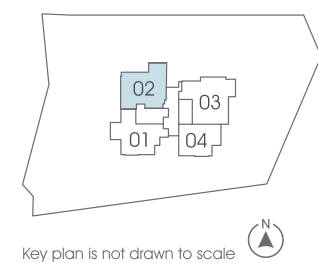
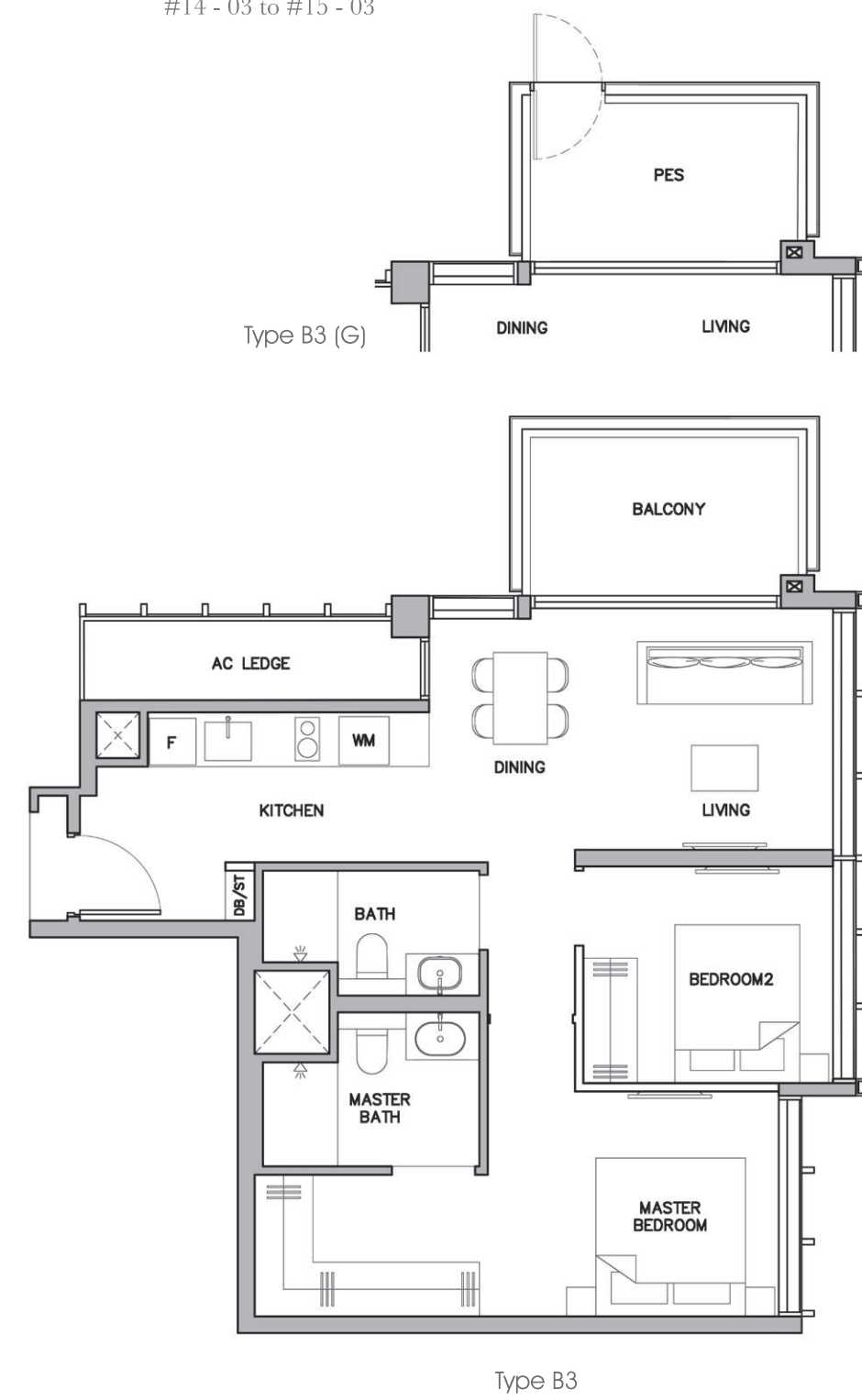

Key plan is not drawn to scale

LEGEND:
F - Fridge
WM - Washer cum Dryer
DB - Distribution Board
ST - Storage

Area includes air-con (a/c) ledge, private enclosed space (PES), balcony and strata void area where applicable. Please refer to the key plan of the unit plans shown in the brochure for orientation. The plans are subject to change as may be approved by relevant authorities. All floor plans are approximate measurements only and are subject to government re-survey. The balcony shall not be enclosed unless with the approved balcony screen. Please refer to the drawing titled approved typical balcony screen design.

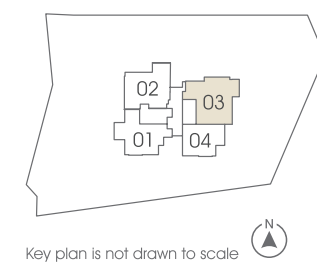

Key plan is not drawn to scale

LEGEND:
F - Fridge
WM - Washer cum Dryer
DB - Distribution Board
ST - Storage

Area includes air-con (a/c) ledge, private enclosed space (PES), balcony and strata void area where applicable. Please refer to the key plan of the unit plans shown in the brochure for orientation. The plans are subject to change as may be approved by relevant authorities. All floor plans are approximate measurements only and are subject to government re-survey. The balcony shall not be enclosed unless with the approved balcony screen. Please refer to the drawing titled approved typical balcony screen design.

2 - BEDROOM SUITE

TYPE B4

77 SQM / 829 SQFT
 #04 - 03 to #05 - 03
 #08 - 03 to #09 - 03
 #12 - 03 to #13 - 03

TYPE B4 (R)

94 SQM / 1,012 SQFT
 #16- 03
 (Inclusive of 17 sqm high-volume void)

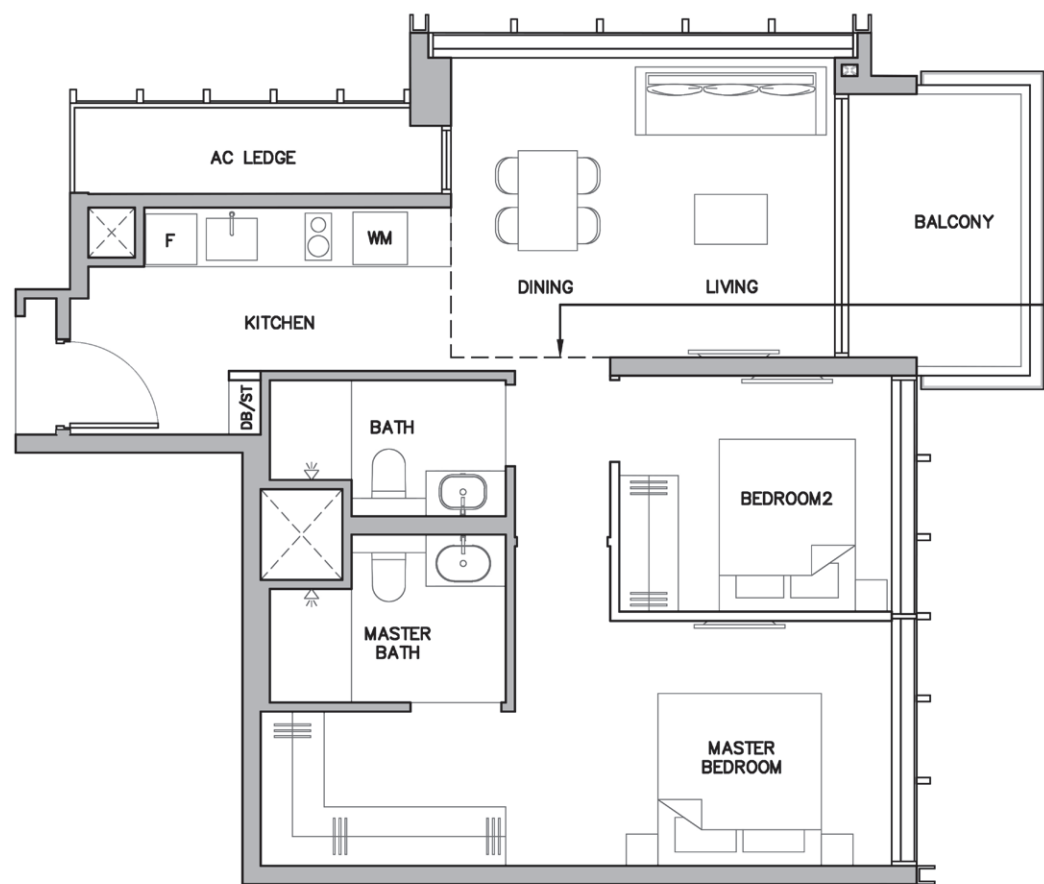

Dotted line denotes high-volume void above living and dining for Type B4 (R)

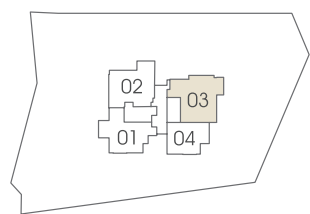

Key plan is not drawn to scale

LEGEND:
 F - Fridge
 WM - Washer cum Dryer
 DB - Distribution Board
 ST - Storage

Area includes air-con (a/c) ledge, private enclosed space (PES), balcony and strata void area where applicable. Please refer to the key plan of the unit plans shown in the brochure for orientation. The plans are subject to change as may be approved by relevant authorities. All floor plans are approximate measurements only and are subject to government re-survey. The balcony shall not be enclosed unless with the approved balcony screen. Please refer to the drawing titled approved typical balcony screen design.

APPROVED TYPICAL BALCONY SCREEN DESIGN

SECTION A-A
 (Typical section of balcony with screen)

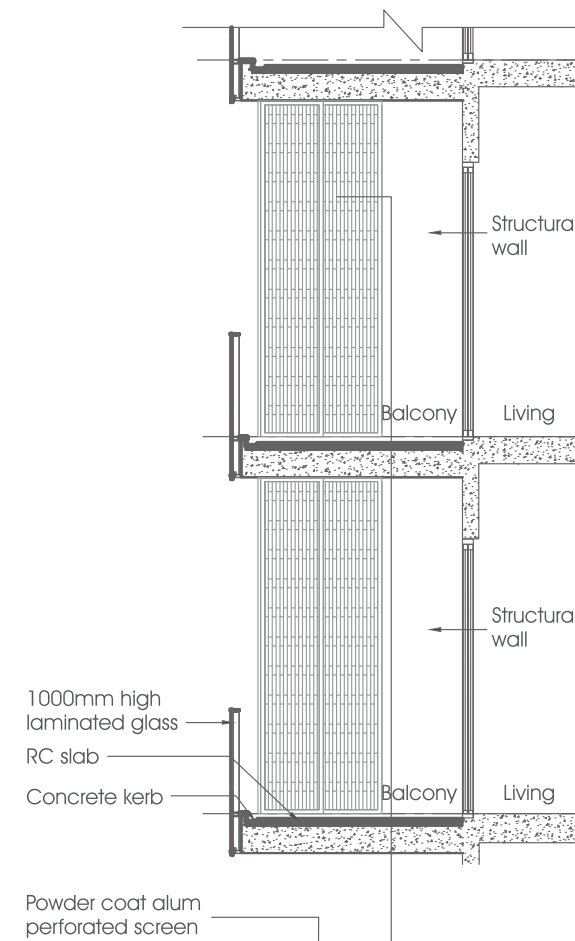

ELEVATION 1 OF BALCONY SCREEN

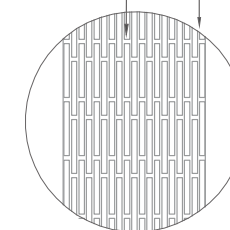
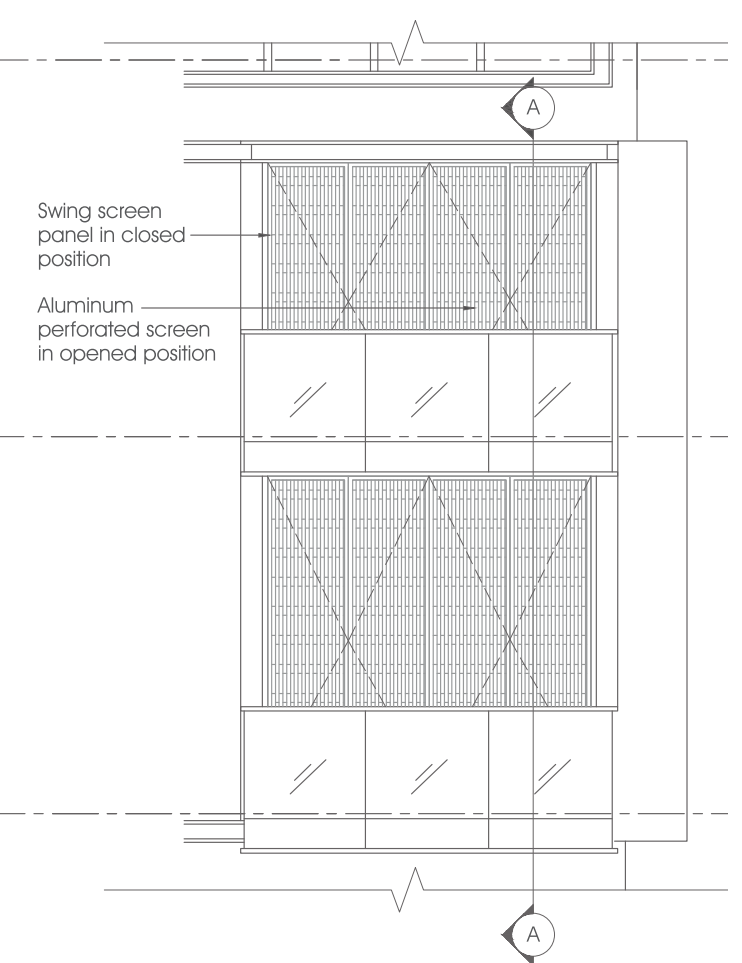

DETAIL A

TYPICAL PLAN OF BALCONY SCREEN

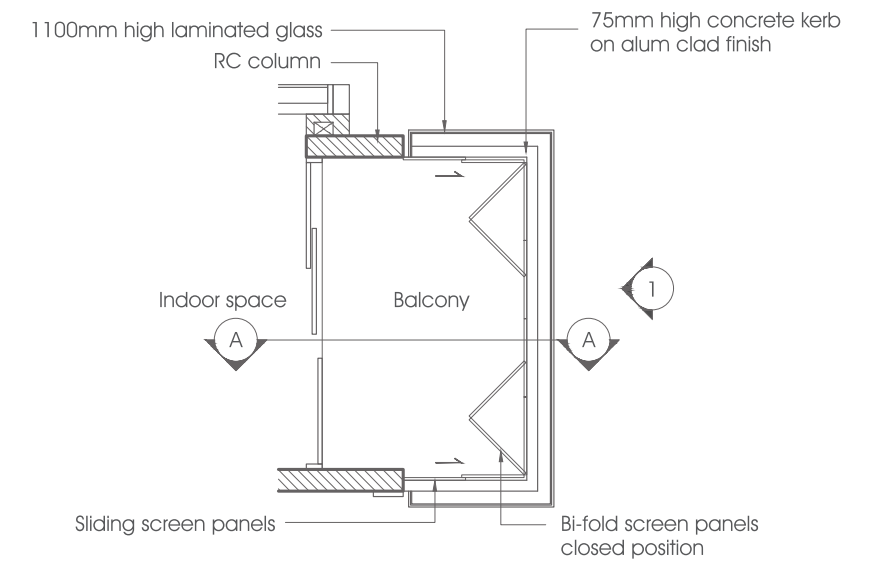

BALCONY SCREEN NOTICE

- The balcony shall not be enclosed unless with the approved balcony screen;
- The proposed balcony screen allows for natural ventilation within the balcony at all times; and
- The proposed balcony screen is capable of being drawn open or retracted fully.
- The balcony screen will NOT be provided in the depicted units. Only partial balcony screen will be shown. The purchasers will have to bear the costs of installing the balcony screen if they wish to, after taking over their respective units.

BP No.: A1805-0001-2018-BP01
 BP Approval Date: 04 July 2019

BP No.: A1805-0001-2018-BP02
 BP Approval Date: 30 September 2019

www.grange1866.com.sg | For Enquiries 6694 7707

Name of Developer: Grange 1866 Pte. Ltd. (UEN: 200713112Z) • Housing Developer's Licence No.: C1353 • Tenure of Land: Estate in fee simple • Approved Building Plan No.: A1805-00001-2018-BP01 Dated 04 July 2019 and A1805-00001-2018-BP02 Dated 30 Sept 2019 • Encumbrances on the Land: Hong Leong Finance Limited • Expected Date of Vacant Possession: 31 Dec 2026 • Expected Date of Legal Completion: 31 Dec 2029 • Location: Lot 00747N TS 24 at Grange Road

While reasonable care has been taken in preparing this brochure, including the statements, specifications, information, depictions and plans, the Developer and its agents do not warrant or guarantee the accuracy or completeness of the contents and information in this brochure and shall not be held responsible for any inaccuracies or omissions. All statements, specifications, information, depictions and plans in this brochure are believed to be accurate at the time of publication and are subject to such approvals and amendments by the relevant authorities and/or the Developer. All visual representations, illustrations, photographs, graphic representations, sales models, pictures and other art renderings are artists' impressions only and are not to be regarded or relied upon as statements or representations of fact. The information and contents of the brochure shall not be regarded or relied upon as statements, representations of fact, offers or warranties (whether expressly or impliedly) by the Developer and its agents, and are not intended to form any part of the contract for the sale of any property. All floor areas in this brochure are approximate measurements only and are subject to final survey. The development and housing units are subject to final inspection by the relevant authorities to comply with current codes of practice. The sale and purchase agreement shall form the entire agreement between the Developer and the purchaser and shall supersede all statements, representations or promises made prior to the signing of the sale and purchase agreement and shall in no way be modified by any such statements, representations or promises made. The show flat / show unit contains interior designs, decorations, furnishings and other effects which, including the brand, colour and model of all materials, fittings, equipment, finishes, installations and appliances supplied which for the avoidance of doubt shall be provided subject to, amongst other things, the Developer's architect's selection, market availability and the sole discretion of the Developer.

